

RACCORDI DI LUCE SYSTEM - JOY SYSTEM

Elementi - Elements

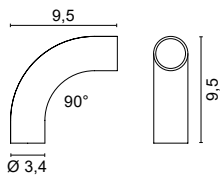

7500

Curva a mandrinare 90°
90° expanding bend

.01	Bianco - White
.02	Nero - Black
.06	Verde - Green
.33	Acciaio - Stell
	Inox AISI 316L
.34	Verniciato corten Painted corten finishing

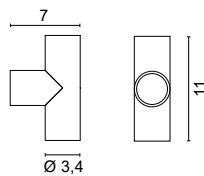

7501

Giunto a T a mandrinare
T joint expanding bend

.01	Bianco - White
.02	Nero - Black
.06	Verde - Green
.33	Acciaio - Stell
	Inox AISI 316L
.34	Verniciato corten Painted corten finishing

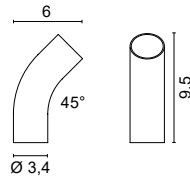

7504

Curva a mandrinare 45°
45° expanding bend

.01	Bianco - White
.02	Nero - Black
.06	Verde - Green
.33	Acciaio - Stell
	Inox AISI 316L
.34	Verniciato corten Painted corten finishing

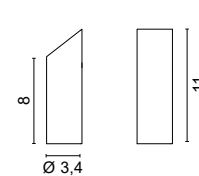

7505

Giunto con taglio a 45°
Joint with 45° cut

.01	Bianco - White
.02	Nero - Black
.06	Verde - Green
.33	Acciaio - Stell
	Inox AISI 316L
.34	Verniciato corten Painted corten finishing

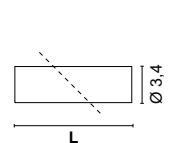

7508

Tubo lineare
Linear tube

.01	Bianco - White
.02	Nero - Black
.06	Verde - Green
.33	Acciaio - Stell
	Inox AISI 316L
.34	Verniciato corten Painted corten finishing

Lunghezza L - Length L

/20	20 cm
/50	50 cm
/100	100 cm
/150	150 cm

Finiture - Finishes



.01 Bianco - White



.02 Nero - Black



.06 Verde - Green



.33 Acciaio satinato - Matt
stell



.34 Verniciato corten
Painted corten finishin

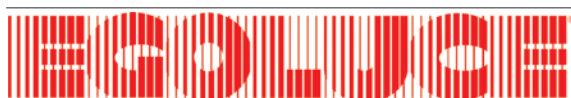

EGOLUCE s.r.l, via I.Newton 12 - 20016 Pero - Milano
telefono +39 02 339586.1 - fax. +39 02 3535112
e-mail: info@egoluce.com - http://www.egoluce.com

RACCORDI DI LUCE SYSTEM - JOY SYSTEM

Congiunzioni - Junctions

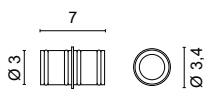

7510

Elemento di giunzione
Junction element

.02 Nero - Black

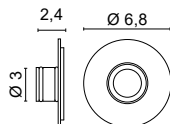

7521

Base a muro in alluminio con copribase
Wall base in aluminum with cover disc

.01 Bianco - White

.02 Nero - Black

.06 Verde - Green

.33 Acciaio - Steel

Inox AISI 316L

.34 Verniciato corten

Painted corten finishing

Optionals

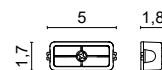

0276

Connettore IP67
IP67 connector

Casseforme e Basi - Formwork and Bases

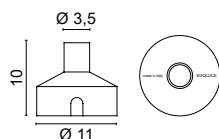

0228/R

Cassforma drenante
Draining junction box

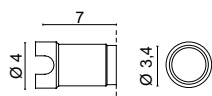

0216

Plastic box

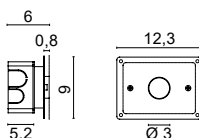

0213

Box + plaster

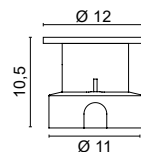

0246/R

Box + plate con viti d'acciaio
Box + plate with steel screws

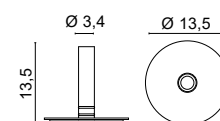

7522

Base con disco copribase
Base with cover disc

.01 Bianco - White

.02 Nero - Black

.06 Verde - Green

.33 Acciaio - Steel

Inox AISI 316L

.34 Verniciato corten

Painted corten finishing



EGOLUCE s.r.l, via I.Newton 12 - 20016 Pero - Milano
telefono +39 02 339586.1 - fax. +39 02 3535112
e-mail: info@egoluce.com - http://www.egoluce.com

RACCORDI DI LUCE SYSTEM - JOY SYSTEM

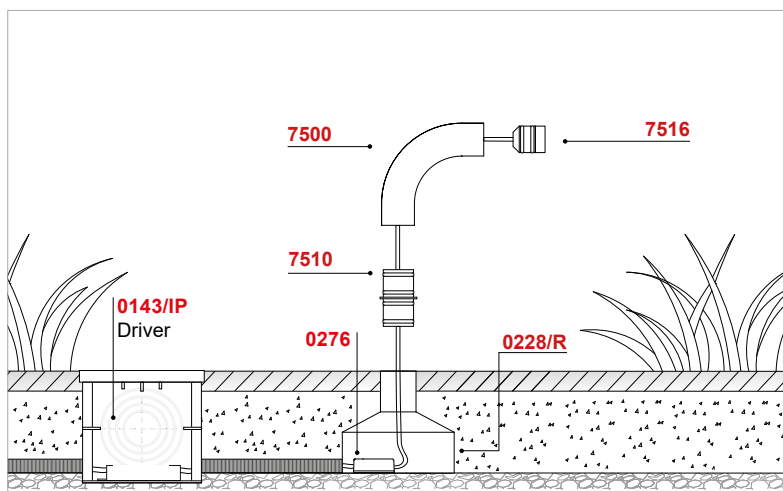
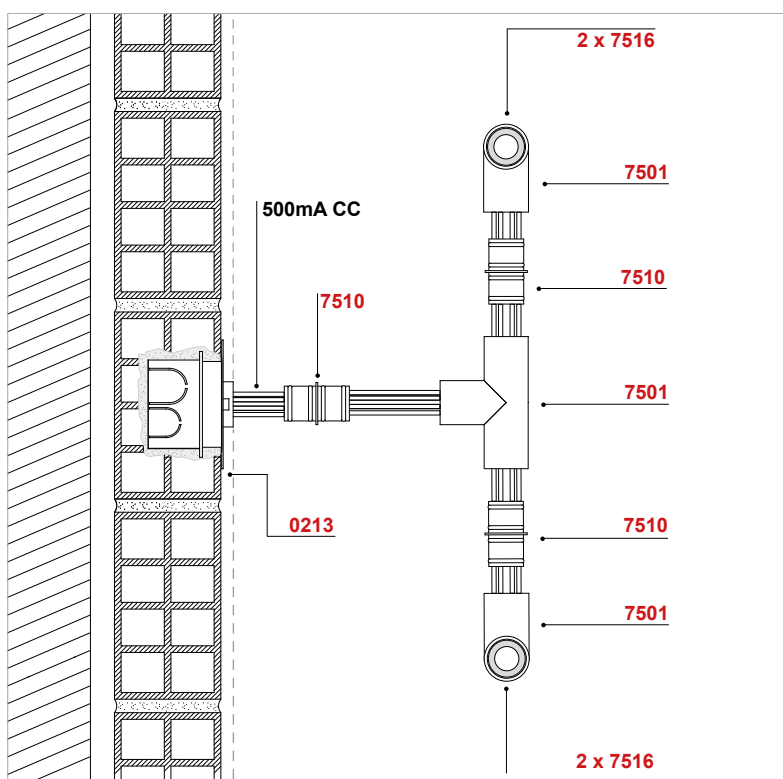
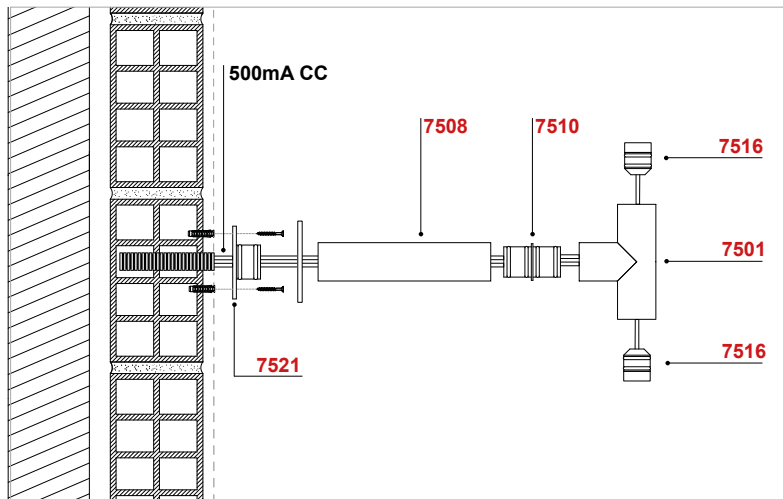

EGOLUCE s.r.l, via I. Newton 12 - 20016 Pero - Milano
 telefono +39 02 339586.1 - fax. +39 02 3535112
 e-mail: info@egoluce.com - http://www.egoluce.com

La presente scheda tecnica è di proprietà di EGOLUCE srl. Tutti i diritti sono riservati. Le fotografie, le descrizioni degli apparecchi, i disegni quotati ed i valori fotometrici menzionati sono a titolo indicativo e non costituiscono alcun impegno per la nostra società che si riserva di apportare, in qualsiasi momento e senza preavviso, tutte le modifiche che riterrà opportune.

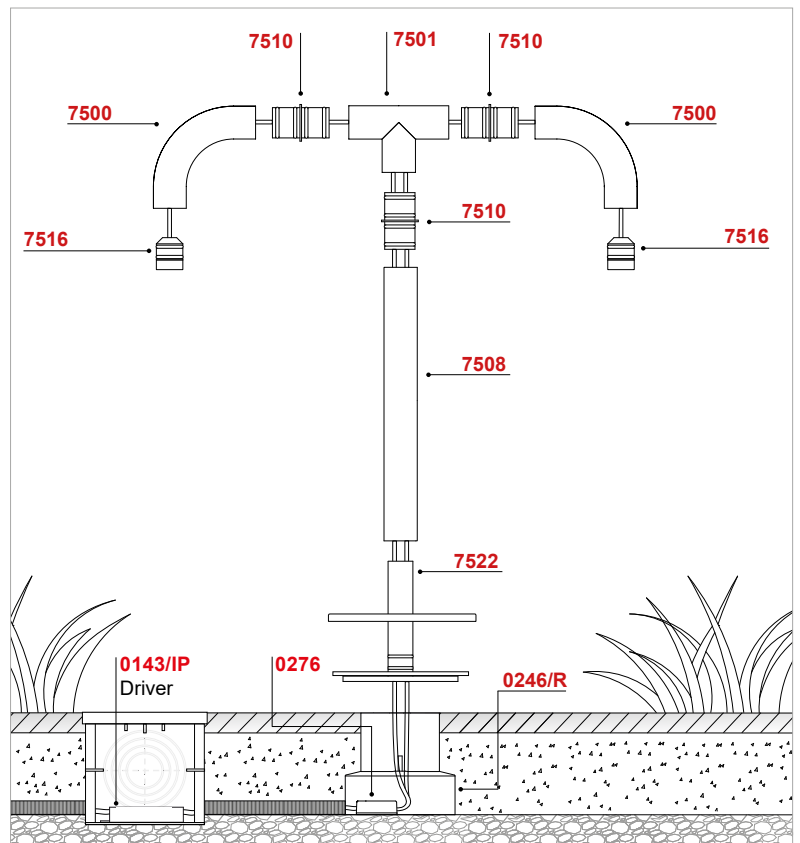
RACCORDI DI LUCE SYSTEM - JOY SYSTEM

I drivers, da ordinare separatamente, devono essere collocati in remoto
 The drivers, to be ordered separately, must be placed remotely

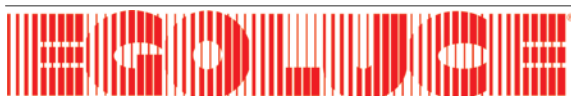

EGOLUCE s.r.l, via I. Newton 12 - 20016 Pero - Milano
 telefono +39 02 339586.1 - fax. +39 02 3535112
 e-mail: info@egoluce.com - <http://www.egoluce.com>

La presente scheda tecnica è di proprietà di EGOLUCE srl. Tutti i diritti sono riservati. Le fotografie, le descrizioni degli apparecchi, i disegni quotati ed i valori fotometrici menzionati sono a titolo indicativo e non costituiscono alcun impegno per la nostra società che si riserva di apportare, in qualsiasi momento e senza preavviso, tutte le modifiche che riterrà opportune.