

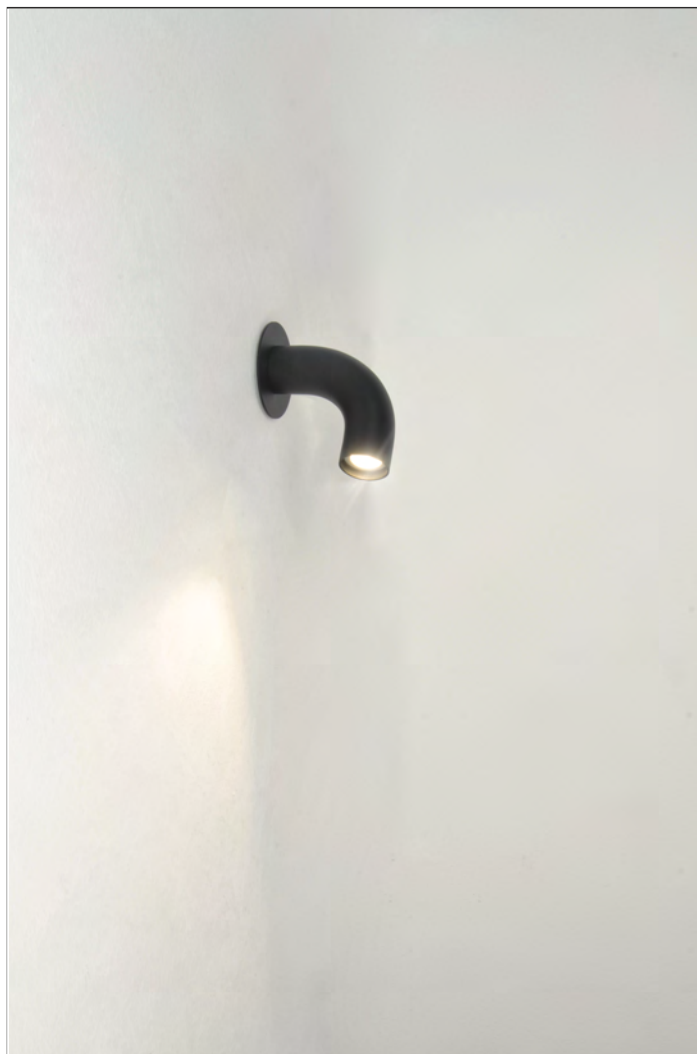





scheda tecnica - data sheet



modello: model:	RACCORDI DI LUCE	
codice: code:	4673	
design:	Officina di Architettura e Design	
anno - year:	2022	
tipologia: typology:	lampada da parete IP65 IP65 wall lamp	
materiali: materials:	acciaio INOX e alluminio stainless steel and aluminum	
luce: light:	radente grazing	
sorgente luminosa: light source:	/W LED 1,5W 500mA 180lm 4000K /WW LED 1,5W 500mA 162lm 3000K /XW LED 1,5W 500mA 153lm 2700K	
life	> 50.000 h	
step MacAdam	3	
Indice di Resa Cromatica: Color Rendering Index:	>90	
grado IP - IP grade:	65	
peso netto - net weight:	0,25 Kg	
finiture - finishes:	.01 bianco .01 white .02 nero .02 black .06 verde .06 green .33 INOX AISI 316L .33 stainless steel .34 verniciato corten .34 painted corten	
alimentatori - drivers:	0127 driver 500mA 1-6 4673 0143/IP driver IP67 500mA 1-7 4673	
marcatura: marking:	CE	
simboli costruttivi: symbols:	     	

Dimensioni - Dimensions

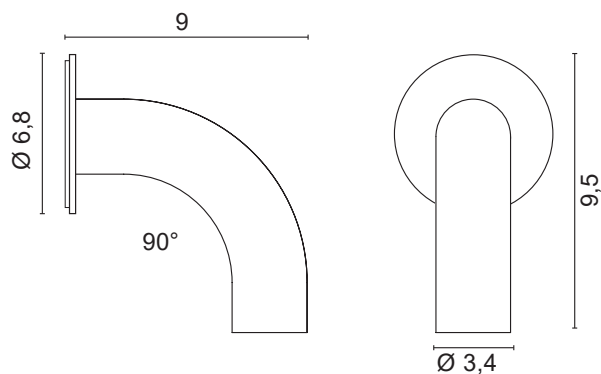

.01 bianco - white



.02 nero - black

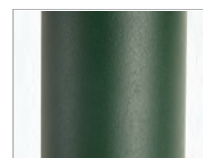

.06 verde - green

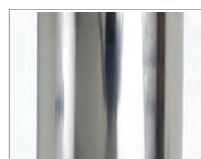
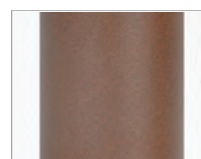
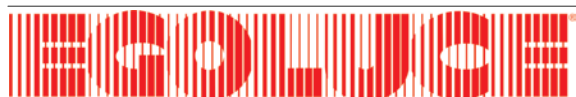
.33 INOX AISI 316L
stainless steel.34 verniciato corten
painted corten

EGOLUCE s.r.l., via I.Newton 12 - 20016 Pero - Milano
 telefono +39 02 339586.1 - fax. +39 02 3535112
 e-mail: info@egoluce.com - http://www.egoluce.com