

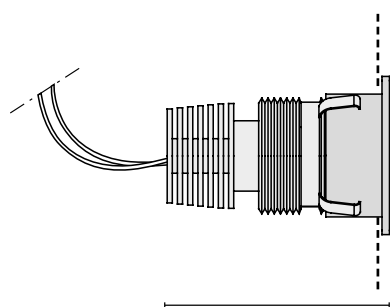

modello: model:	PIX TONDO	
codice: code:	6322	
design:	UT Egoluce	
anno - year:	2007	
tipologia: typology:	faretto ad incasso recessed lamp	
materiali: materials:	alluminio aluminium	
luce: light:	diretta direct	
sorgente luminosa: light sources:		
LED code	optic beams	LED color
/XW	/11 /25 /45	LED max 1,5W 500mA 199lm 2700K
/WW	/11 /25 /45	LED max 1,5W 500mA 210lm 3000K
/W	/11 /25 /45	LED max 1,5W 500mA 221lm 4000K
life:	> 50.000 h	
step MacAdam:	3	
Indice di Resa Cromatica: Color Rendering Index:	>80	
grado IP - IP grade:	40	
peso netto - net weight:	0,06 Kg	
finiture - finishes:	.01 bianco .01 white .32 nichel satinato .32 nickel mat	
optional:	0209 adattatore per doghe slats adapter 0213 kit: box + plaster traforato kit: box + perforated plaster 0234 controcassa in materiale plastico plastic box	
marcatura: marking:	CE	
simboli costruttivi: symbols:	  IP40  	

Dimensioni - Dimensions



5,4

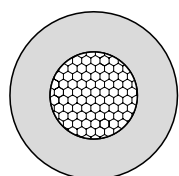

Ø 3,8

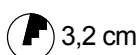

3,2 cm

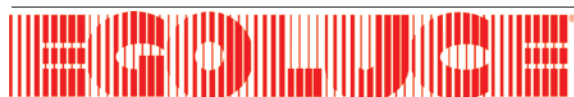
SOLO COLLEGAMENTO IN SERIE - ONLY SERIAL CONNECTION

EGOLUCE s.r.l., via I. Newton 12 - 20016 Pero - Milano
 telefono +39 02 339586.1 - fax. +39 02 3535112
 e-mail: info@egoluce.com - http://www.egoluce.com

**0209**

Adattatore per doghe
Slats adapter

**0213**

KIT: box + Plaster

**0234**

Controcassa in materiale plastico
Plastic box

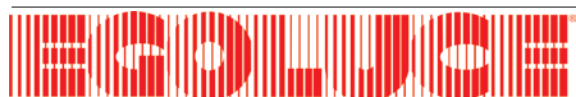

EGOLUCE s.r.l., via I. Newton 12 - 20016 Pero - Milano
telefono +39 02 339586.1 - fax. +39 02 3535112
e-mail: info@egoluce.com - <http://www.egoluce.com>

LED DRIVERS in corrente continua
LED DRIVERS constant current
0127

LED driver
 IN: 100 - 240V
 OUT: 500 mA
 1-6 Power LED

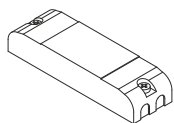



11,6 x 3,4 x 2 cm  4 cm

SELV CLASS 2  

0169/50

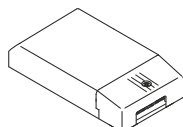
Multipower LED driver
 IN: 220 - 240V
 OUT: 500mA
 min. 4 max 15 Power LED



13 x 7,5 x 3 cm  8,5 cm

SELV 

DRIVERS DIMMERABILI in corrente continua
DIMMABLE LED DRIVERS constant current
0129 Dimmer LED

Multipower dimmable driver
 IN: 110 - 240V
 OUT: 500 mA, 1-14 Power LED

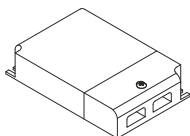



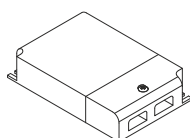

10,5 x 7 x 2,2 cm  7,2 cm SELV    

0129/DALI Dimmer LED

Multipower dimmable driver
 IN: 110 - 240V
 OUT: 500 mA, 2-12 Power LED



10,5 x 7 x 2,2 cm  7,2 cm SELV   

0141/DALI

LED driver
 IN: 110 - 240V
 OUT: 500 mA, 1-11 Power LED

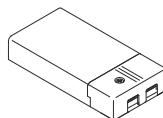

11,1 x 5,2 x 2,5 cm  5,5 cm   

0141/DIM

LED driver
 IN: 110 - 240V
 OUT: 500 mA, 1-11 Power LED

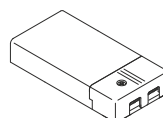

Versione PUSH non sincronizzabile - PUSH version not synchronizable

11,1 x 5,2 x 2,5 cm  5,5 cm    

0145 Dimmer LED Maxi

Multipower dimmable driver

IN: 110 - 240V
 OUT: 500 mA, 1-21 Power LED

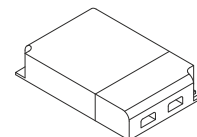

12,3 x 8 x 2,2 cm  8,4 cm SELV    

0145/DALI Dimmer LED Maxi

Multipower dimmable driver

IN: 110 - 240V
 OUT: 500 mA, 1-21 Power LED

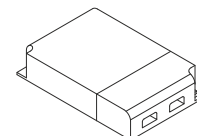

12,3 x 8 x 2,2 cm  8,4 cm SELV     

0133

Cavo di sincronizzazione per dimmer LED
 Synchronization cable for LED dimmer
 (art. 0129 - art. 0129/DALI - art. 0145 - art. 0145/DALI)



L 150 cm

0726/DIM

LED dimmer
 TAGLIO DI FASE (IGBT-TRIAC, TRAILING EDGE-LEADING EDGE)
 PHASE CUT-OFF (IGBT-TRIAC, TRAILING EDGE-LEADING EDGE)
 IN: 220 - 240V
 OUT: 24V - 20W
 500 mA, 1-12 Power LED

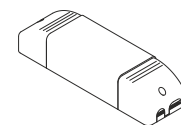

16,5 x 4,5 x 3,5 cm  5,6 cm SELV  IGBT-TRIAC 

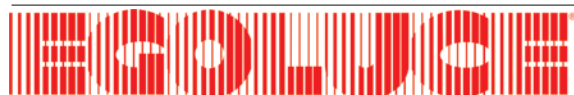

EGOLUCE s.r.l., via I. Newton 12 - 20016 Pero - Milano
 telefono +39 02 339586.1 - fax. +39 02 3535112
 e-mail: info@egoluce.com - http://www.egoluce.com