



modello:
model:

NEWTON SPOT

codice:
code:

6342

design:

U.T. Egoluce

anno - year:

2017

tipologia:
typology:

**proiettore da incasso orientabile
adjustable recessed projector**

materiali:
materials:

**struttura in alluminio
aluminum structure**

luce:
light:

**diretta
direct**

sorgente luminosa:
light source:

LED code	optic beams			lm source	lm output
/W	4000K	/24	/38	/58	LED 8,7W 17,5V 500mA 1223lm 1016lm
/W/ST	4000K	satin glass			LED 8,7W 17,5V 500mA 1223lm 942lm
/WW	3000K	/24	/38	/58	LED 8,7W 17,5V 500mA 1156lm 960lm
/WW/ST	3000K	satin glass			LED 8,7W 17,5V 500mA 1156lm 890lm
/XW	2700K	/24	/38	/58	LED 8,7W 17,5V 500mA 1106lm 918lm
/XW/ST	2700K	satin glass			LED 8,7W 17,5V 500mA 1106lm 852lm

life:

> 50.000 h

step MacAdam:

3

Indice di Resa Cromatica:
Color Rendering Index:

>90

grado IP - IP grade:

20

peso netto - net weight:

0,55 Kg

finiture - finishes:

.01 bianco .01 white
.02 nero .02 black

optionals:

0267 frangiluce - louvre
**0274 schermo anti abbagliamento
anti-glare screen**

marcatura:
marking:

CE

simboli costruttivi:
symbols:



Dimensioni - Dimensions

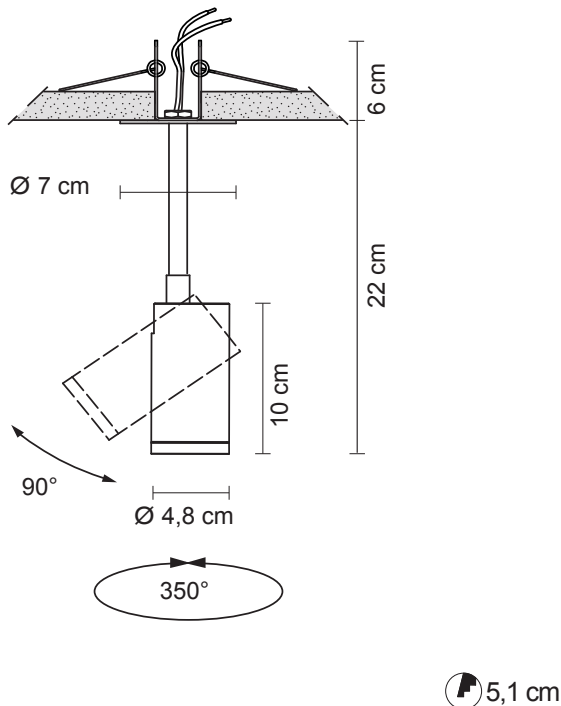

La presente scheda tecnica è di proprietà di EGOLUCE srl. Tutti i diritti sono riservati. Le fotografie, le descrizioni degli apparecchi, i disegni quotati ed i valori fotometrici menzionati sono a titolo indicativo e non costituiscono alcun impegno per la nostra società che si riserva di apportare, in qualsiasi momento e senza preavviso, tutte le modifiche che riterrà opportune.

EGOLUCE s.r.l, via I.Newton 12 - 20016 Pero - Milano
telefono +39 02 339586.1 - fax. +39 02 3535112
e-mail: info@egoluce.com - http://www.egoluce.com

**0267**Frangiluce
Louvres

.01	Bianco - <i>White</i>
.02	Nero - <i>Black</i>

**0274**Schermo antiabbagliamento
Anti-glare screen

.01	Bianco - <i>White</i>
.02	Nero - <i>Black</i>

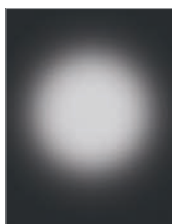
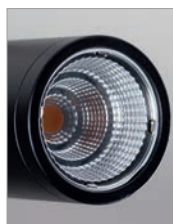
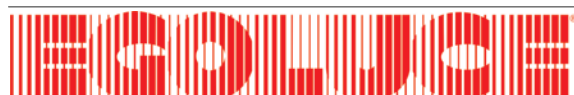
Ottiche Disponibili - Available Optics**/24**Ottica fascio stretto per luce d'accento
Narrow beam optic for accent lighting**/38**Ottica fascio medio
Medium beam optic**/58**Ottica fascio largo
Wide beam optic**/ST**Ottica fascio diffuso per illuminazione generale
Diffused light optic for general lighting

EGOLUCE s.r.l, via I.Newton 12 - 20016 Pero - Milano
 telefono +39 02 339586.1 - fax. +39 02 3535112
 e-mail: info@egoluce.com - <http://www.egoluce.com>

LED DRIVERS in corrente continua LED DRIVERS constant current

0127

LED driver
IN: 100 - 240V
OUT: 500 mA
1 COB LED

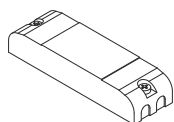

11,6 x 3,4 x 2 cm 4 cm

0147/COB

LED driver
IN: 220 - 240V
OUT: 500 mA
1-2 COB LED

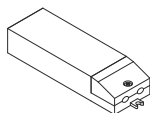

12,5 x 3,8 x 2,4 cm 4,2 cm

0149/COB

LED driver
IN: 220 - 240V
OUT: 500 mA
1 COB LED

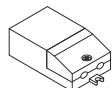

7,6 x 3,9 x 2,2 cm 4,2 cm

0169/50

Multipower LED driver

IN: 220 - 240V
OUT: 500mA
1-3 COB LED

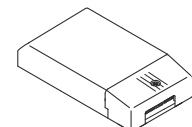

13 x 7,5 x 3 cm 8,5 cm

DRIVERS DIMMERABILI in corrente continua DIMMABLE LED DRIVERS constant current

0129 Dimmer LED Multipower dimmable driver

IN: 110 - 240V
OUT: 500 mA
1-2 COB LED

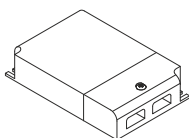

10,5 x 7 x 2,2 cm 7,2 cm SELV

0129/DALI Dimmer LED

Multipower dimmable driver

IN: 110 - 240V
OUT: 500 mA
1-2 COB LED

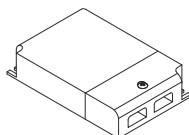

10,5 x 7 x 2,2 cm 7,2 cm SELV

0141/DALI

LED driver

IN: 110 - 240V
OUT: 500 mA
1-2 COB LED

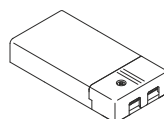

11,1 x 5,2 x 2,5 cm 5,5 cm

0141/DIM

LED driver

IN: 110 - 240V
OUT: 500 mA,
1-2 COB LED

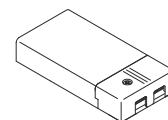

Versione PUSH non sincronizzabile - PUSH version not synchronizable

11,1 x 5,2 x 2,5 cm 5,5 cm

0145 Dimmer LED Maxi

Multipower dimmable driver

IN: 110 - 240V
OUT: 500 mA
1-3 COB LED

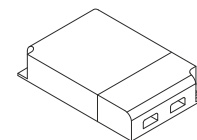

12,3 x 8 x 2,2 cm 8,4 cm SELV

0145/DALI Dimmer LED Maxi

Multipower dimmable driver

IN: 110 - 240V
OUT: 500 mA
1-3 COB LED

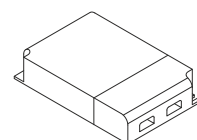

12,3 x 8 x 2,2 cm 8,4 cm SELV

0133

Cavo di sincronizzazione per dimmer LED
Synchronization cable for dimmer LED
(art. 0129 - art. 0129/DALI - art. 0145 - art. 0145/DALI)



L 150 cm

0726/DIM

LED dimmer
TAGLIO DI FASE (IGBT-TRIAC, TRAILING EDGE-LEADING EDGE)
PHASE CUT-OFF (IGBT-TRIAC, TRAILING EDGE-LEADING EDGE)
IN: 220 - 240V
OUT: 24V - 20W
500 mA
1-2 COB LED

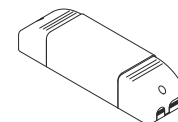

16,5 x 4,5 x 3,5 cm 5,6 cm IGBT-TRIAC SELV

0734/DIM

LED dimmer

Alimentatori elettronici dimmerabili (IGBT-TRIAC) in corrente continua
Direct current dimmable (TRAILING EDGE-LEADING EDGE) electronic drivers

IN: 220 - 240V
OUT: 500 mA
1 COB LED

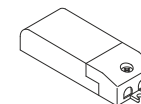

8,7 x 3,8 x 2,1 cm 4,2 cm IGBT-TRIAC SELV

UNITA' DI EMERGENZA LED LED EMERGENCY UNIT

0115/EM

LED Emergency Unit
Kit Inverter + Battery + LED indicator

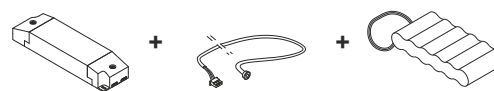

15,5 x 5,2 x 2,5 cm 80 cm 13,5 x 4,5 x 2,3 cm

