



modello:
model:

CERCHIO

codice:
code:

6389

design:

UT Egoluce

anno - year:

2012

tipologia:

faretto da incasso calpestabile

typology:

trampleable recessed spotlight

materiali:

acciaio INOX AISI 316L

materials:

stainless steel AISI 316L

luce:

diretta/diffusa

light:

direct/diffuse

sorgente luminosa:

/W LED 1,5W 500mA 221lm 4000K

light sources:

/WW LED 1,5W 500mA 210lm 3000K

/XW LED 1,5W 500mA 199lm 2700K

/B LED 1W 350mA LED BLU

life:

> 50.000 h

step MacAdam:

3

Indice di Resa Cromatica:

>80

Color Rendering Index:

grado IP - IP grade:

IP67

peso netto - net weight:

0,20 Kg

finiture:

.33 acciaio satinato

finishes:

.33 matt steel

optional:

0217 controcassa in materiale plastico
plastic box

0250 cassaforma drenante + connettore IP
draining junction + IP connector

marcatura:

CE

marking:

simboli costruttivi:



symbols:

SOLO COLLEGAMENTO IN SERIE - ONLY SERIAL CONNECTION

Dimensioni - Dimension

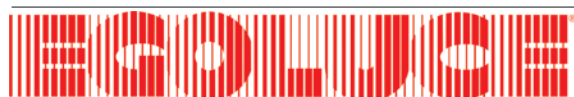
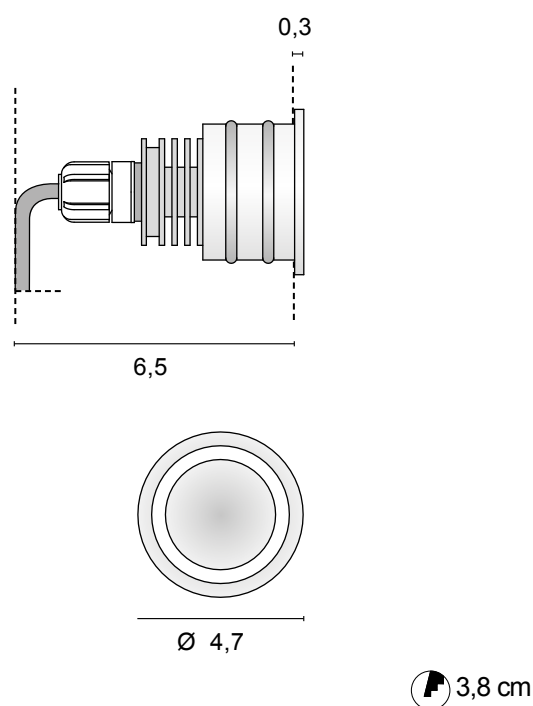

EGOLUCE s.r.l., via I. Newton 12 - 20016 Pero - Milano
telefono +39 02 339586.1 - fax. +39 02 3535112
e-mail: info@egoluce.com - http://www.egoluce.com

**0217**

Controcassa in materiale plastico
Plastic box

**0250**

KIT: cassaforma drenante + Conettore IP
KIT: draining junction + IP connector

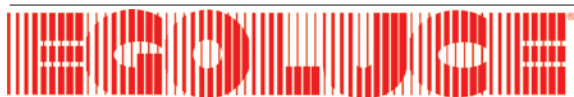

EGOLUCE s.r.l., via I. Newton 12 - 20016 Pero - Milano
 telefono +39 02 339586.1 - fax. +39 02 3535112
 e-mail: info@egoluce.com - <http://www.egoluce.com>

La presente scheda tecnica è di proprietà di EGOLUCE srl. Tutti i diritti sono riservati. Le fotografie, le descrizioni degli apparecchi, i disegni quotati ed i valori fotometrici menzionati sono a titolo indicativo e non costituiscono alcun impegno per la nostra società che si riserva di apportare, in qualsiasi momento e senza preavviso, tutte le modifiche che riterrà opportune.

LED DRIVERS in corrente continua LED DRIVERS constant current

0127

LED driver
IN: 100 - 240V
OUT: 500mA
1-6 Power LED

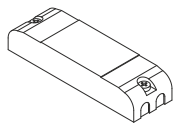

11,6 x 3,4 x 2 cm 4 cm



SELV CLASS 2

0169/50

Multipower LED driver

IN: 220 - 240V
OUT: 500mA
4-15 Power LED

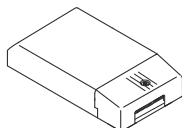

13 x 7,5 x 3 cm 8,5 cm

SELV

DRIVERS DIMMERABILI in corrente continua DIMMABLE LED DRIVERS constant current

0129 Dimmer LED

Multipower dimmable driver

IN: 110 - 240V
OUT: 500mA,
1-14 Power LED

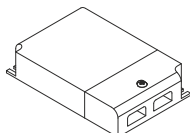

10,5 x 7 x 2,2 cm 7,2 cm SELV

0129/DALI Dimmer LED

Multipower dimmable driver

IN: 110 - 240V
OUT: 500mA
2-12 Power LED

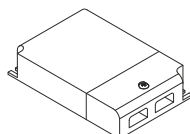

10,5 x 7 x 2,2 cm 7,2 cm SELV

0141/DALI

LED driver

IN: 110 - 240V
OUT: 500mA,
1-11 Power LED

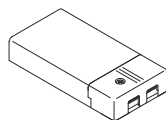

11,1 x 5,2 x 2,5 cm 5,5 cm



0141/DIM

LED driver

IN: 110 - 240V
OUT: 500mA,
1-11 Power LED

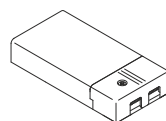

Versione PUSH non sincronizzabile - PUSH version not synchronizable

11,1 x 5,2 x 2,5 cm 5,5 cm

0145 Dimmer LED Maxi

Multipower dimmable driver

IN: 110 - 240V
OUT: 500mA,
1- 21 Power LED

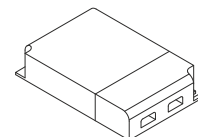

12,3 x 8 x 2,2 cm 8,4 cm SELV

0145/DALI Dimmer LED Maxi

Multipower dimmable driver

IN: 110 - 240V
OUT: 500mA,
1- 21 Power LED

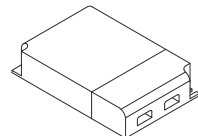

12,3 x 8 x 2,2 cm 8,4 cm SELV

0133

Cavo di sincronizzazione per dimmer LED
Synchronization cable for LED dimmers
(art. 0129 - art. 0129/DALI - art. 0145 - art. 0145/DALI)



L 150 cm

IP LED DRIVERS in corrente continua IP LED DRIVERS constant current

0143/IP

LED driver
IN: 220 - 240V
OUT: 500mA
1-7 Power LED

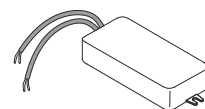

8,2 x 3,9 x 2 cm 4,5 cm

SELV IP67

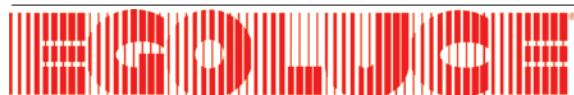

EGOLUCE s.r.l., via I. Newton 12 - 20016 Pero - Milano
telefono +39 02 339586.1 - fax. +39 02 3535112
e-mail: info@egoluce.com - http://www.egoluce.com