

modello: model:	<b>SPOOK</b>
codice: code:	<b>6418</b>
design:	UT Egoluce
anno - year:	2013
tipologia: tipology:	<b>barra luminosa calpestabile</b> <b>trampleable light bar</b>
materiali: materials:	<b>corpo in metacrilato coestruso anti-UV</b> <b>anti-UV coextruded methacrylate structure</b>
luce: light:	<b>diffusa</b> <b>diffuse</b>
sorgente luminosa: light sources:	/W LED 24V 9,6W 1080lm 4000K CRI>90 /WW LED 24V 9,6W 1020lm 3000K CRI>90
grado IP - IP grade:	<b>67</b>
peso netto - net weight:	<b>1,60 Kg</b>
finiture: finishes:	<b>.01 bianco</b> <b>.01 bianco</b>
marcatura: marking:	<b>CE</b>
simboli costruttivi: symbols:	

## Dimensioni - Dimensions

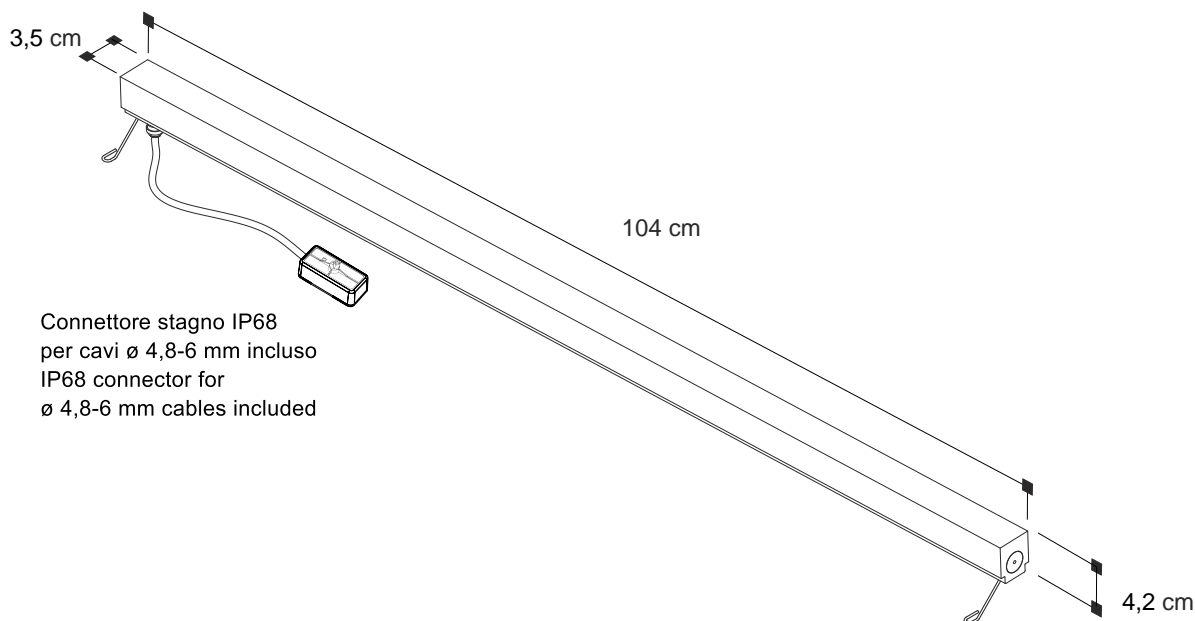

**Montaggio esclusivamente con cassaforma - Mounting only with recessed box**

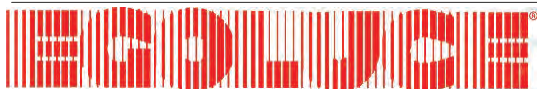

EGOLUCE s.r.l., via I. Newton 12 - 20016 Pero - Milano  
telefono +39 02 339586.1 - fax. +39 02 3535112  
e-mail: info@egoluce.com - http://www.egoluce.com

La presente scheda tecnica è di proprietà di EGOLUCE srl. Tutti i diritti sono riservati. Le fotografie, le descrizioni degli apparecchi, disegni quotati ed i valori fotometrici menzionati sono a titolo indicativo e non costituiscono alcun impegno per la nostra società che si riserva di apportare, in qualsiasi momento e senza preavviso, tutte le modifiche che riterrà opportune.

**SPOOK** LED source 9,6W/mt 120LED/mt CRI>90**SU MISURA - CUSTOM SIZE**

Tabella lunghezze disponibili. Le misure si riferiscono alle lunghezze totali delle lampade.

Table of available lengths. Measures are referred to complete fixtures including closing heads.

cm	watt	3000K (WW)	lm	4000K (W)	lm
14	1W	A6417.01/14/WW	102	A6417.01/14/W	108
24	1,9W	A6417.01/24/WW	204	A6417.01/24/W	216
34	2,9W	A6417.01/34/WW	306	A6417.01/34/W	324
44	3,8W	A6417.01/44/WW	408	A6417.01/44/W	432
54	4,8W	<b>6417.01/WW</b>	510	<b>6417.01/W</b>	540
64	5,8W	A6417.01/64/WW	612	A6417.01/64/W	648
74	6,7W	A6417.01/74/WW	714	A6417.01/74/W	756
84	7,7W	A6417.01/84/WW	816	A6417.01/84/W	864
94	8,6W	A6417.01/94/WW	918	A6417.01/94/W	972
104	9,6W	<b>6418.01/WW</b>	1020	<b>6418.01/W</b>	1080
114	10,6W	A6417.01/114/WW	1122	A6417.01/114/W	1188
124	11,5W	A6417.01/124/WW	1224	A6417.01/124/W	1296
134	12,5W	A6417.01/134/WW	1326	A6417.01/134/W	1404
144	13,4W	A6417.01/144/WW	1428	A6417.01/144/W	1512
154	14,4W	<b>6419.01/WW</b>	1530	<b>6419.01/W</b>	1620

**SOLO COLLEGAMENTO IN PARALLELO - ONLY PARALLEL CONNECTION**

## accessori - accessories



Cassaforma di partenza  
con tappi ed elemento  
per manutenzione lampada

Starting recessed box with  
caps and element for lamp  
maintenance

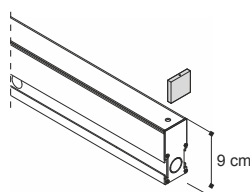

<b>0298/54</b>	55,1x4x9 cm	0,90 Kg
<b>0298/104</b>	105,1x4x9 cm	1,70 Kg
<b>0298/154</b>	115,1x4x9 cm	2,60 Kg
<b>0298/308</b>	309,1x4x9 cm	5,70 Kg



Cassaforma  
I tappi di chiusura sono forniti  
con la cassaforma di partenza

Recessed box  
The end stoppers are included  
in the starting box.

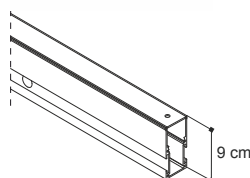

<b>0299/54</b>	54,1x4x9 cm	0,80 Kg
<b>0299/104</b>	104,1x4x9 cm	1,60 Kg
<b>0299/154</b>	114,1x4x9 cm	2,50 Kg
<b>0299/308</b>	308,1x4x9 cm	5,60 Kg



2 staffe ancoraggio per  
cassaforma

2 anchor brackets for  
recessed box

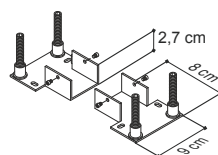
**0295**

2 giunti per unione  
cassaforme

2 joints for recessed box

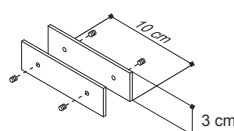
**0293/S**

2 tappi di chiusura per  
cassaforma

2 end stoppers for  
recessed box

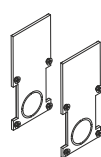
**0301**

EGOLUCE s.r.l., via I.Newton 12 - 20016 Pero - Milano  
telefono +39 02 339586.1 - fax. +39 02 3535112  
e-mail: info@egoluce.com - http://www.egoluce.com

La presente scheda tecnica è di proprietà di EGOLUCE srl. Tutti i diritti sono riservati. Le fotografie, le descrizioni degli apparecchi, disegni quotati ed i valori fotometrici menzionati sono a titolo indicativo e non costituiscono alcun impegno per la nostra società che si riserva di apportare, in qualsiasi momento e senza preavviso, tutte le modifiche che riterrà opportune.

Codifiche sistema Spook per la composizione di linee luminose continue

Spook system codes to compose endless light lines

6417.01 cm.54  
6418.01 cm.104  
6419.01 cm.154  
A6417.01 cm.14 ... cm 144

Connettore stagno IP68  
per cavi  $\varnothing$  4,8-6 mm incluso  
IP68 connector for  
 $\varnothing$  4,8-6 mm cables included

0293/S  
2 giunti per unione cassaforme  
2 joint for recessed boxes

0301  
2 tappi di  
chiusura  
2 end  
stoppers

0295  
2 staffe ancoraggio cassaforma  
2 anchor brackets

0299/54  
0299/104  
0299/154  
0299/308  
Cassaforme  
Recessed Box

9 cm.  
4 cm.  
0298/54  
0298/104  
0298/154  
0298/308

Cassaforma di partenza con elemento per manutenzione lampada.  
Starting recessed box with element for lamp maintenance.

\* I tappi di chiusura sono forniti con la cassaforma di partenza.



EGOLUCE s.r.l., via I. Newton 12 - 20016 Pero - Milano  
telefono +39 02 339586.1 - fax. +39 02 3535112  
e-mail: info@egoluce.com - http://www.egoluce.com

La presente scheda tecnica è di proprietà di EGOLUCE srl. Tutti i diritti sono riservati. Le fotografie, le descrizioni degli apparecchi, i disegni quotati ed i valori fotometrici menzionati sono a titolo indicativo e non costituiscono alcun impegno per la nostra società che si riserva di apportare, in qualsiasi momento e senza preavviso, tutte le modifiche che riterrà opportune.

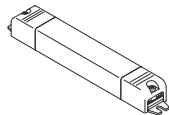
Codice  
Articolo**DRIVERS a tensione costante**  
**DRIVERS constant voltage****0155****LED driver**  
IN: 100 - 240V  
OUT: 24V - 13W

15,8 x 2,2 x 2 cm

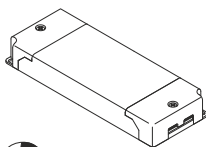

SELV

**0156****LED driver**  
IN: 100 - 240V  
OUT: 24V - 25W

14,5 x 5,5 x 2 cm

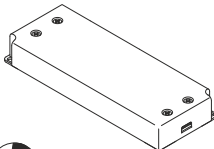

SELV

**0157****LED driver**  
IN: 220 - 240V  
OUT: 24V - 75W

18,4 x 6,1 x 2,9 cm

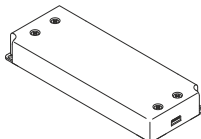

SELV

**0160****LED driver**  
IN: 220 - 240V  
OUT: 24V - 50W

16,7 x 6 x 2,9 cm

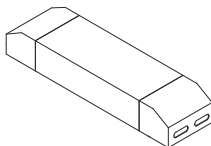

SELV

**0161/100****LED driver**  
IN: 220 - 240V  
OUT: 24V - 100W

21 x 7,5 x 3,5 cm

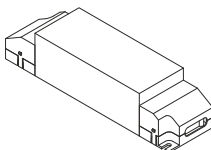

SELV

**0162****LED driver**  
IN: 220 - 240V  
OUT: 24V - 150W

24 x 6 x 5 cm

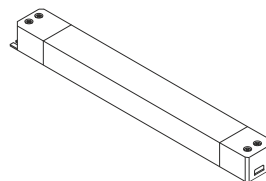

SELV

Codice  
Articolo**0182****LED driver**  
IN: 220 - 240V  
OUT: 24V - 180W

34,5 x 5 x 3,5 cm

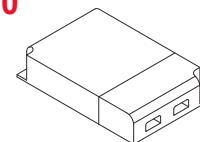

SELV

**DRIVERS DIMMERABILI a tensione costante**  
**DIMMABLE LED DRIVERS constant voltage****0717/DIM60****LED dimmer**  
IN: 220 - 240V  
OUT: 24V - 60W

12,6 x 8,1 x 3 cm

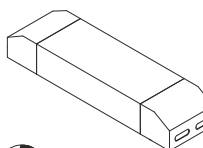

SELV

**0717/DIM100****LED dimmer**  
IN: 220 - 240V  
OUT: 24V - 100W

21 x 7,5 x 3,5 cm

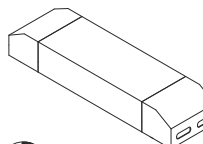

SELV

**0717/DIM150****LED dimmer**  
IN: 220 - 240V  
OUT: 24V - 150W

21 x 7,5 x 3,5 cm



SELV

**0727/DIM****LED dimmer**TAGLIO DI FASE (TRIAC, TRAILING EDGE-LEADING EDGE)  
PHASE CUT-OFF (TRIAC, TRAILING EDGE-LEADING EDGE)IN: 220 - 240V  
OUT: 24V - 45W

18 x 6 x 3,5 cm



TRIAC

SELV

**0728/DIM****LED dimmer**TAGLIO DI FASE (TRIAC, TRAILING EDGE-LEADING EDGE)  
PHASE CUT-OFF (TRIAC, TRAILING EDGE-LEADING EDGE)IN: 220 - 240V  
OUT: 24V - 75W

18 x 6 x 3,5 cm



TRIAC

SELV



La presente scheda tecnica è di proprietà di EGOLUCE srl. Tutti i diritti sono riservati. Le fotografie, le descrizioni degli apparecchi, i disegni quotati ed i valori fotometrici menzionati sono a titolo indicativo e non costituiscono alcun impegno per la nostra società che si riserva di apportare, in qualsiasi momento e senza preavviso, tutte le modifiche che riterrà opportune.

EGOLUCE s.r.l., via I.Newton 12 - 20016 Pero - Milano  
telefono +39 02 339586.1 - fax. +39 02 3535112  
e-mail: info@egoluce.com - http://www.egoluce.com

Codice  
Articolo**DIMMER** a tensione costante  
**DIMMER** constant voltage**0110/DIM****LED dimmer**

IN: 12/24/48V max 12A

OUT: 12/24/48V

16,4 x 3,8 x 2,5 cm  4,4 cm**0110/DIM/MINI****LED dimmer**

IN: 12/24/48V

OUT: 12/24/48V 6A

13,2 x 2,2 x 1,9 cm  2,8 cm**UNITA' DI EMERGENZA LED**  
**LED EMERGENCY UNIT****0115/EM****LED Emergency Unit**

Kit Inverter + Battery + LED indicator

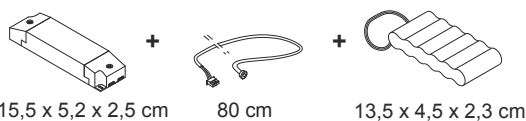

15,5 x 5,2 x 2,5 cm    80 cm    13,5 x 4,5 x 2,3 cm

**0115/EM/3****LED Emergency Unit**

Kit Inverter + Battery + LED indicator 3h

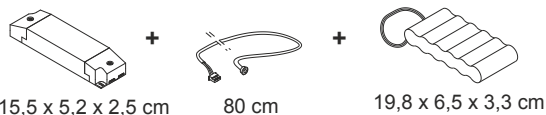

15,5 x 5,2 x 2,5 cm    80 cm    19,8 x 6,5 x 3,3 cm

Codice  
Articolo**DRIVERS IP** a tensione costante  
**IP DRIVERS** constant voltage**0033/IP****LED driver**

IN: 220 - 240V

OUT: 24V - 14,4W

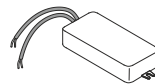
3,9 x 8 x 2 cm  4,2 cm

IP67 SELV

**0034/IP****LED driver**

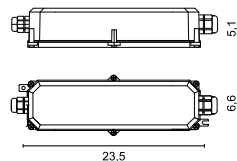

IN: 220 - 240V

OUT: 24V - 70W

 IP67 SELV
**0035/IP****LED driver**

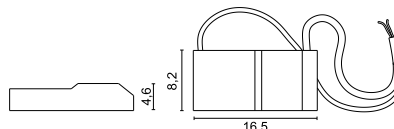

IN: 220 - 240V

OUT: 24V - 160W

 9,6 cm IP65 SELV
**0037/IP****LED driver**

IN: 230 - 250V

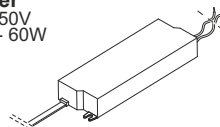
OUT: 24V - 60W

13,8 x 4 x 2,2 cm  4,5 cm

IP65 SELV

**0038/IP****LED driver**

IN: 230 - 250V

OUT: 24V - 100W

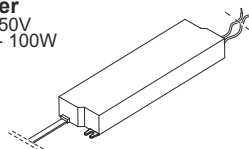

17,5 x 5 x 3,1 cm  5,8 cm

IP65 SELV

**0039/IP****LED driver**

IN: 230 - 250V

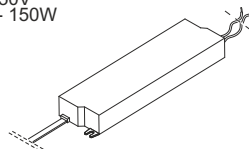
OUT: 24V - 150W

17,5 x 5 x 3,1 cm  5,8 cm

IP65 SELV

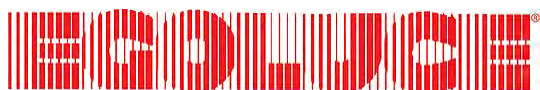

La presente scheda tecnica è di proprietà di EGOLUCE srl. Tutti i diritti sono riservati. Le fotografie, le descrizioni degli apparecchi, i disegni quotati ed i valori fotometrici menzionati sono a titolo indicativo e non costituiscono alcun impegno per la nostra società che si riserva di apportare, in qualsiasi momento e senza preavviso, tutte le modifiche che riterrà opportune.

EGOLUCE s.r.l., via I. Newton 12 - 20016 Pero - Milano  
 telefono +39 02 339586.1 - fax. +39 02 3535112  
 e-mail: info@egoluce.com - http://www.egoluce.com