



modello:
modell:

SNORKY INCASSO

codice:
code:

6698

design:

UT Egoluce

anno - year:

2019

tipologia:

faretto ad incasso orientabile

tipology:

adjustable recessed spotlight

materiali:

alluminio

materials:

aluminium

luce:

diretta

light:

direct

lampadine - bulbs:

**/W LED max 2W 500mA 209lm 4000K
/WWLED max 2W 500mA 199lm 3000K
/XW LED max 2W 500mA 189lm 2700K**

grado IP - IP grade:

40

peso netto - net weight:

0,12 Kg

finitura:

.01 bianco

finishing:

.01 white

.02 nero

.02 black

marcatura:

marking:

simboli costruttivi:

symbols:



 **5,9 cm - Foro incasso - Ceiling cut out**

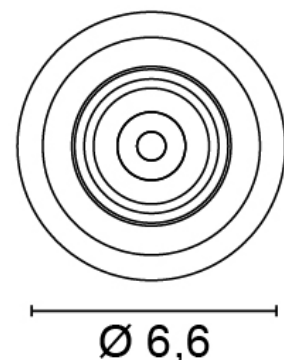
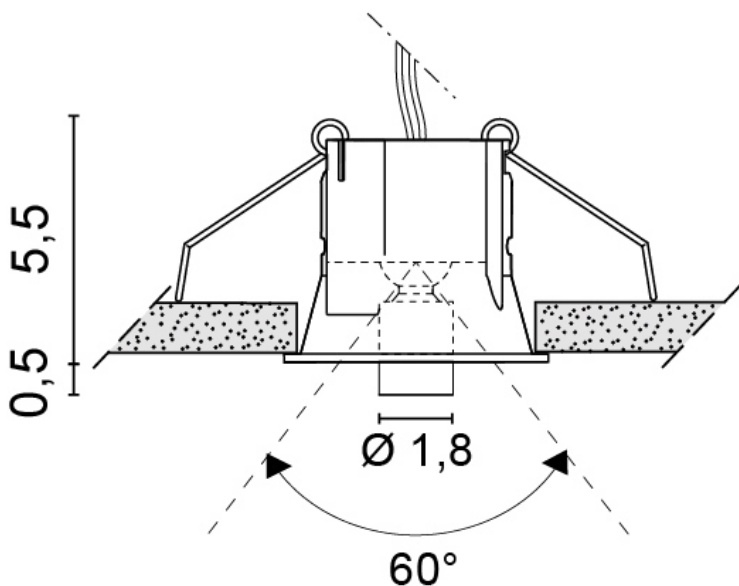

SOLO COLLEGAMENTO IN SERIE - ONLY SERIAL CONNECTION



EGOLUCE s.r.l., via I. Newton 12 - 20016 Pero - Milano
telefono +39 02 339586.1 - fax. +39 02 3535112
e-mail: info@egoluce.com - http://www.egoluce.com

La presente scheda tecnica è di proprietà di EGOLUCE srl. Tutti i diritti sono riservati. Le fotografie, le descrizioni degli apparecchi, disegni quotati ed i valori fotometrici menzionati sono a titolo indicativo e non costituiscono alcun impegno per la nostra società che si riserva di apportare, in qualsiasi momento e senza preavviso, tutte le modifiche che riterrà opportune.

Codice
Articolo

LED DRIVERS in corrente continua.
LED DRIVERS constant current.

0127

LED driver
IN: 100 - 240V
OUT: 500 mA
1-6 Power LED 2W
1-6 Power LED 2W - art.0120-0122

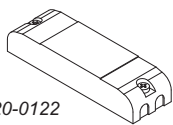

11,6 x 3,4 x 2 cm



0169/50

Multipower LED driver

IN: 220 - 240V
OUT: 500mA
min.4-max15 Power LED 2W
min.4-max15 Power LED - art.0120-0122

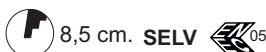
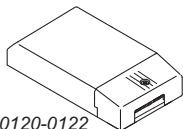

13 x 7,5 x 3 cm



DRIVERS DIMMERABILI in corrente continua.
DIMMABLE LED DRIVERS constant current.

0129 Dimmer Led
Multipower dimmable driver

IN: 110 - 240V
OUT: 500 mA, 1-14 Power LED

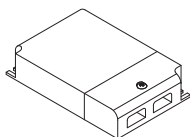

10,5 x 7 x 2,2 cm 7,2 cm.

0129/DALI Dimmer Led

Multipower dimmable driver
IN: 110 - 240V
OUT: 500 mA, 2-12 Power LED

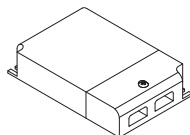

10,5 x 7 x 2,2 cm 7,2 cm.

0141/DALI

LED driver
IN: 110 - 240V
OUT: 500 mA, 1-11 Power LED

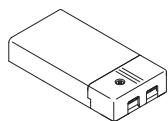

11,1 x 5,2 x 2,5 cm

0141/DIM

LED driver
IN: 110 - 240V
OUT: 500 mA, 1-11 Power LED

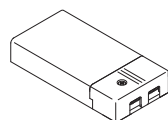

Versione PUSH non sincronizzabile - PUSH version not synchronizable

11,1 x 5,2 x 2,5 cm

Codice
Articolo

0145 Dimmer Led Maxi
Multipower dimmable driver

IN: 110 - 240V
OUT: 500 mA, 1-21 power LED

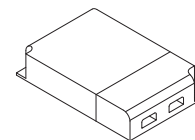

12,3 x 8 x 2,2 cm 8,4 cm.

0145/DALI Dimmer Led Maxi
Multipower dimmable driver

IN: 110 - 240V
OUT: 500 mA, 1-21 power LED

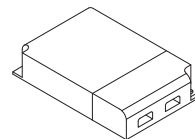

12,3 x 8 x 2,2 cm 8,4 cm.

0133

Cavo di sincronizzazione per dimmer Led
Synchronization cable for dimmer Led
(art. 0129 - art. 0129DALI - art. 0145 - art. 0145DALI)



Lunghezza: 150cm.

0726/DIM

LED dimmer
TAGLIO DI FASE (IGBT-TRIAC, TRAILING EDGE-LEADING EDGE)
PHASE CUT-OFF (IGBT-TRIAC, TRAILING EDGE-LEADING EDGE)
IN: 220 - 240V
OUT: 24V - 20W
500 mA, 1-12 Power LED

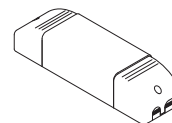

16,5 x 4,5 x 3,5 cm 5,6 cm.

IP LED DRIVERS in corrente continua.
IP LED DRIVERS constant current.

0143/IP

LED driver
IN: 220 - 240V
OUT: 500 mA
1-8 Power LED 1W

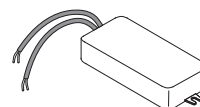

8,2 x 3,9 x 2 cm 4,5 cm.

EGOLUCE

La presente scheda tecnica è di proprietà di EGOLUCE srl. Tutti i diritti sono riservati. Le fotografie, le descrizioni degli apparecchi, i disegni quotati ed i valori fotometrici menzionati sono a titolo indicativo e non costituiscono alcun impegno per la nostra società che si riserva di apportare, in qualsiasi momento e senza preavviso, tutte le modifiche che riterrà opportune.

EGOLUCE s.r.l, via I. Newton 12 - 20016 Pero - Milano
telefono +39 02 339586.1 - fax. +39 02 3535112
e-mail: info@egoluce.com - http://www.egoluce.com