

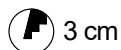

modello: model:	TOP IP	
codice: code:	6740	
design:	UT Egoluce	
anno - year:	2022	
tipologia: typology:	faretto da incasso recessed spotlight	
materiali: materials:	alluminio aluminium	
luce: light:	diretta direct	
sorgente luminosa: light sources:	/XW LED max 1,5W 500mA 199lm 2700K /WW LED max 1,5W 500mA 210lm 3000K /W LED max 1,5W 500mA 221lm 4000K	
life:	> 50.000 h	
step MacAdam:	3	
Indice di Resa Cromatica: Color Rendering Index:	>80	
grado IP - IP grade:	44	
peso netto - net weight:	0,04 Kg	
finiture - finishes:	.01 bianco .01 white .02 nero .02 black	
optional:	0216 controcassa in materiale plastico plastic box 0213 kit: box + plaster traforato kit: box + perforated plaster	
marcatura: marking:	CE	
simboli costruttivi: symbols:	  IP44  	

Dimensioni - Dimensions

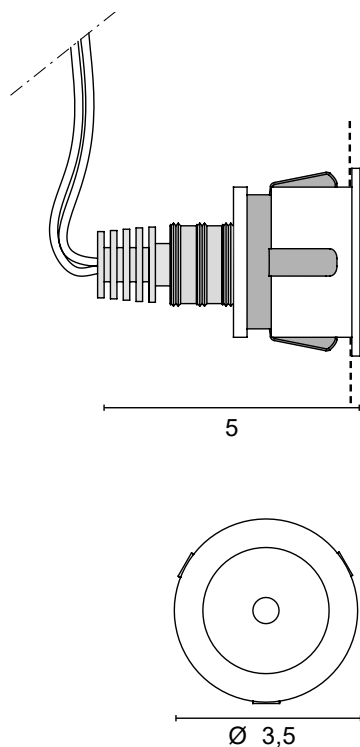

SOLO COLLEGAMENTO IN SERIE - ONLY SERIAL CONNECTION

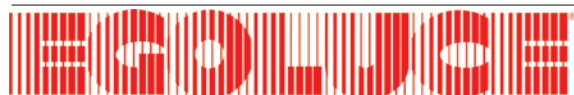

EGOLUCE s.r.l., via I.Newton 12 - 20016 Pero - Milano
telefono +39 02 339586.1 - fax. +39 02 3535112
e-mail: info@egoluce.com - http://www.egoluce.com

**0213**

KIT: box + plaster traforato
 KIT: box + perforated plaster

**0216**

Controcassa in materiale plastico
 Plastic box

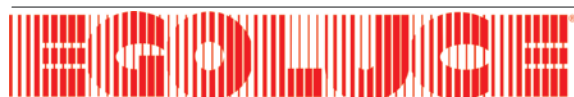
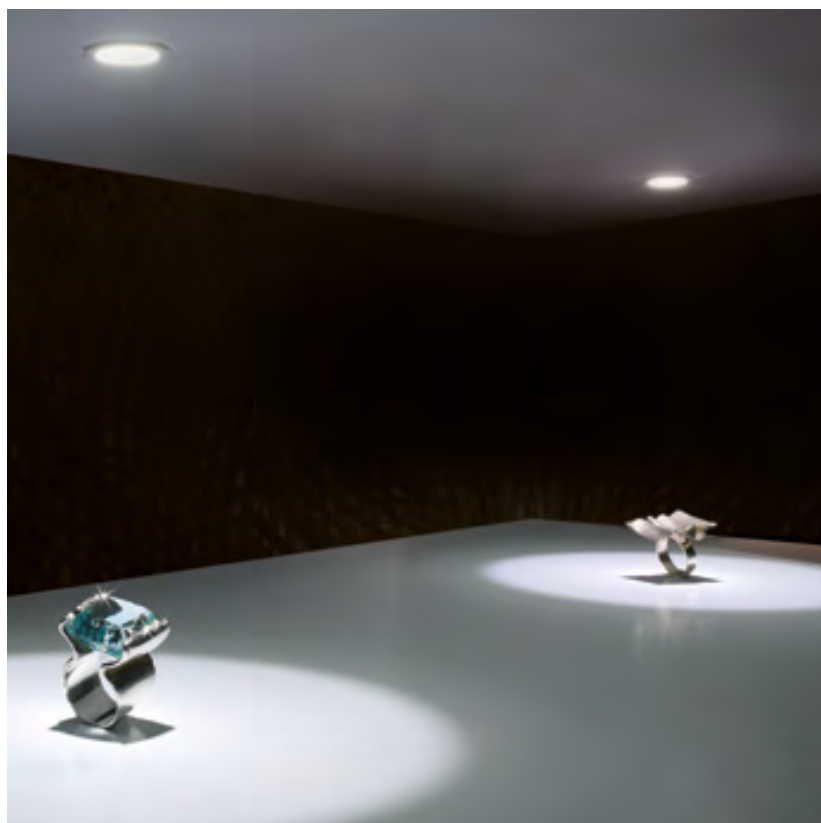

EGOLUCE s.r.l., via I. Newton 12 - 20016 Pero - Milano
 telefono +39 02 339586.1 - fax. +39 02 3535112
 e-mail: info@egoluce.com - <http://www.egoluce.com>

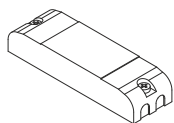
LED DRIVERS in corrente continua
LED DRIVERS constant current
0127
LED driver
 IN: 100 - 240V
 OUT: 500 mA
 1-6 Power LED

11,6 x 3,4 x 2 cm 4 cm

SELV CLASS 2

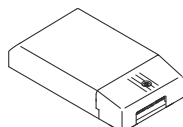
0169/50
Multipower LED driver
 IN: 220 - 240V
 OUT: 500mA
 min. 4 max 15 Power LED

13 x 7,5 x 3 cm 8,5 cm

SELV

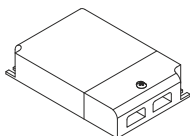
DRIVERS DIMMERABILI in corrente continua
DIMMABLE LED DRIVERS constant current
0129 Dimmer LED
Multipower dimmable driver
 IN: 110 - 240V
 OUT: 500 mA, 1-14 Power LED

10,5 x 7 x 2,2 cm 7,2 cm SELV

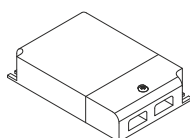
0129/DALI Dimmer LED
Multipower dimmable driver
 IN: 110 - 240V
 OUT: 500 mA, 2-12 Power LED

10,5 x 7 x 2,2 cm 7,2 cm SELV

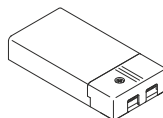
0141/DALI
LED driver
 IN: 110 - 240V
 OUT: 500 mA, 1-11 Power LED

11,1 x 5,2 x 2,5 cm 5,5 cm

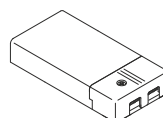
0141/DIM
LED driver
 IN: 110 - 240V
 OUT: 500 mA, 1-11 Power LED

Versione PUSH non sincronizzabile - PUSH version not synchronizable

11,1 x 5,2 x 2,5 cm 5,5 cm

0145 Dimmer LED Maxi
Multipower dimmable driver

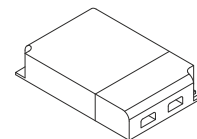
 IN: 110 - 240V
 OUT: 500 mA, 1-21 Power LED

12,3 x 8 x 2,2 cm 8,4 cm SELV

0145/DALI Dimmer LED Maxi
Multipower dimmable driver

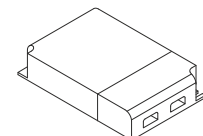
 IN: 110 - 240V
 OUT: 500 mA, 1-21 Power LED

12,3 x 8 x 2,2 cm 8,4 cm SELV

0133
 Cavo di sincronizzazione per dimmer LED
 Synchronization cable for LED dimmer
 (art. 0129 - art. 0129/DALI - art. 0145 - art. 0145/DALI)

L 150 cm

0726/DIM
LED dimmer

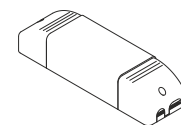
 TAGLIO DI FASE (IGBT-TRIAC, TRAILING EDGE-LEADING EDGE)
 PHASE CUT-OFF (IGBT-TRIAC, TRAILING EDGE-LEADING EDGE)
 IN: 220 - 240V
 OUT: 24V - 20W
 500 mA, 1-12 Power LED

16,5 x 4,5 x 3,5 cm 5,6 cm SELV IGBT-TRIAC

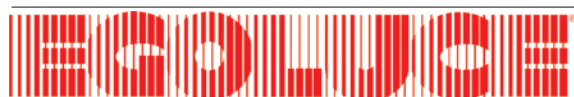
 EGOLUCE s.r.l., via I. Newton 12 - 20016 Pero - Milano
 telefono +39 02 339586.1 - fax. +39 02 3535112
 e-mail: info@egoluce.com - http://www.egoluce.com